

2025

Forester

Accessories



Genuine Subaru Forester Accessories

An evolution in sophisticated Subaru SUV design.

Introducing the all-new 2025 Subaru Forester. It's completely redesigned inside and out. It's safe, capable and versatile, engineered with a modern design, updated technology and convenient new features. With Genuine Subaru Accessories, you'll be equipped for any adventure to help make every road you navigate even more rewarding.

CONTENTS

■ Protection and Security	3-9
■ Style.....	9-14
■ Comfort and Convenience	15-18
■ Lifestyle	19-25
■ Audio / Media	26
■ Pet-friendly	27-32
■ STI Brand	33-34



Genuine Subaru Accessories are backed by the vehicle's 3-year or 36,000-mile limited warranty, even if the accessory is installed after retail delivery. Genuine Subaru Accessories installed after the 3-year/36,000-mile warranty period are backed by a 1-year, unlimited mileage warranty. See your warranty and maintenance booklet for more details.

Genuine Subaru Lifestyle Accessories by Thule® have a limited lifetime warranty for the original purchaser.

Ready for wherever you may roam.

No matter where the road takes you, the Subaru Forester is designed to help you and your passengers safely arrive at your destination. Genuine Subaru Accessories help you travel without worry and keep your vehicle looking its best.

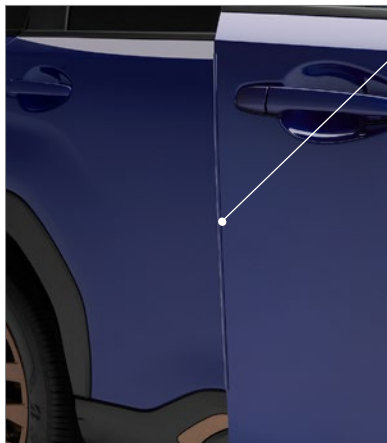

Door Edge Guards

Help protect your door edges from dings and chips with custom-fit, body color-matched, stainless steel Door Edge Guards. They help preserve the appearance of your Subaru while seamlessly blending into the door design.

- SOA801P100M7 (Autumn Green Metallic)**
- SOA801P100Q7 (Brilliant Bronze Metallic)**
- SOA801P100T5 (Crimson Red Pearl)**
- SOA801P100V2 (Crystal Black Silica)**
- SOA801P100W6 (Crystal White Pearl)**
- SOA801P100G7 (Horizon Blue Pearl)**
- SOA801P100TQ (Ice Silver Metallic)**
- SOA801P100M3 (Magnetite Gray Metallic)**
- SOA801P100J4 (River Rock Pearl)**
- SOA801P100G8 (Sapphire Blue Pearl)**

Sapphire Blue Pearl applicable to Sport trims only.



Engine Block Heater

Warms engine coolant to promote easier starting in extreme cold conditions. Plugs into a household electrical outlet.

A091SFL100



Battery Warmer

Warms vehicle's battery for easier starting in extremely cold weather. Plugs into a household electrical outlet.

J6010FS000



Extensive testing is performed on Genuine Subaru Accessories to help ensure strict Subaru engineering specifications and safety requirements are met.



Body Side Molding

Attractive, color-matched moldings coordinate with the styling of the vehicle while helping to protect doors from unsightly dings.

- J101SSL400M6 (Autumn Green Metallic)**
- J101SSL400Q8 (Brilliant Bronze Metallic)**
- J101SSL400T1 (Crimson Red Pearl)**
- J101SSL400V3 (Crystal Black Silica)**
- J101SSL400W7 (Crystal White Pearl)**
- J101SSL400G7 (Horizon Blue Pearl)**
- J101SSL400TR (Ice Silver Metallic)**
- J101SSL400M4 (Magnetite Gray Metallic)**
- J101SSL400W2 (River Rock Pearl)**
- J101SSL400G9 (Sapphire Blue Pearl)**

Sapphire Blue Pearl applicable to Sport trims only.



Seat Cover – Front

Keep your front seats tidy and protect them from spills, stains, dust and dirt. Great for life on the go.

- ✦ *Custom-fitted, machine-washable and water-resistant.*
- ✦ *Made with a polyester front and polyurethane coated back.*
- ✦ *Full coverage to help protect seatbacks from wear and tear.*
- ✦ *Slips into the seatback pocket to help prevent damage to pocket upholstery.*

F411SSL000



Wheel Locks

Bright chrome wheel locks help deter theft of wheels and tires. Includes four locks and key.

B321SFL000



Wheel Lug Nut and Lock Set – Black

Match your dark colored wheels by changing all lug nuts to black for improved styling. Includes four locks and key to help deter theft of wheels and tires.

B321SFL020



Mud Flaps

Help protect the paint finish from chips and the undercarriage from rust and corrosion. Includes Forester logo.

- ◆ *Serve as a protective barrier between the tires and wheel well.*
- ◆ *Help minimize water, dirt and mud spray.*
- ◆ *Evaluated for durability and to withstand various weather conditions.*

J101SSL500

Cannot be used in conjunction with Splash Guards.

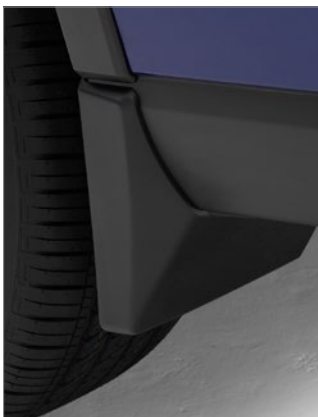

Splash Guards

Help protect vehicle paint finish from stones and road grime.

- ◆ *Engineered to help reduce wind noise and aerodynamic drag.*
- ◆ *Durability tested to withstand extreme weather and driving conditions.*

J101SSL000

Ground clearance is reduced when Splash Guards are installed. Cannot be used in conjunction with Mud Flaps.



Rear Seatback Protector

Provides additional protection to the rear seatbacks when lowering the seats to transport larger cargo. Use in conjunction with the Cargo Tray for optimal protection.

J501SSL260



All-Weather Floor Liners

High wall design helps protect the vehicle carpet from spills, snow, sand, mud, dirt and moisture.

- ✦ Engineered to precisely fit the Forester footwell area.
- ✦ Constructed with soft, durable materials to help minimize warping, fading or tearing vs. aftermarket alternatives.

J501SSL100

Not intended for use on top of Carpeted Floor Mats.



Cargo Sidewall Protector

Extend protection to the cargo area wheel well trim panels. Set of two.

- ✦ Engineered for a precise fit vs. aftermarket parts.
- ✦ Texture- and pattern-matched with the Rear Seatback Protector and Cargo Tray to create a seamless appearance.

J501SSL250



Auto-Dimming Exterior Mirror with Approach Light

LED lights in each exterior mirror illuminate the ground next to and towards the rear of the vehicle upon approaching the vehicle or unlocking your doors with the keyless entry system. During nighttime driving, mirrors dim in unison with the rearview mirror to reduce headlight glare. Requires Auto-Dimming (Interior) Mirror on Base, Premium, Sport, and Limited trims.

- ✦ *Enhances nighttime driving safety.*
- ✦ *Dimming level is regulated by level of light detected by Auto-Dimming (Interior) Mirror.*

J201SFN000



Door Scuff Protector

A durable, easy to clean plastic shell that protects your doors from common shoe scuffs and other scrapes when entering and exiting your vehicle. The unique texture complements the design of the Forester. Comes in a set of two.

J131SSL000



Rear Bumper Cover

Helps protect the upper surface of the painted bumper from scratches and scuffs.

E771SSL000



Battery Charger and Maintainer

Custom engineered for Subaru vehicles, the Battery Charger and Maintainer efficiently charges 12-volt lead acid batteries to maximize battery life. Comes with alligator clamps for quick connections and ring-terminals for more permanent connections, to help ensure your vehicle's battery is ready for your next adventure.

- ✦ Fully automatic charging with LED lights and countdown timer to indicate remaining charge time.
- ✦ 'Try' LED light indicates when you can attempt to start your vehicle.
- ✦ 'Reconditioning' mode restores deeply discharged batteries.
- ✦ Reverse polarity protection.
- ✦ Designed with a rubber bumper to protect both the accessory and the vehicle during use.

SOA9010001

Engine Under Guard

Custom designed to fit your Forester and provide additional protection from minor road debris. The aluminum Engine Under Guard is a strong, lightweight product, engineered to directly replace the original plastic under cover, while maintaining easy access to the oil drain plug for regular maintenance.

- ✦ Durable and corrosion-resistant.
- ✦ Maintains compliance with all vehicle regulations.
- ✦ Does not adversely impact vehicle safety systems.
- ✦ Maintains long-term engine durability.

E515SSL000

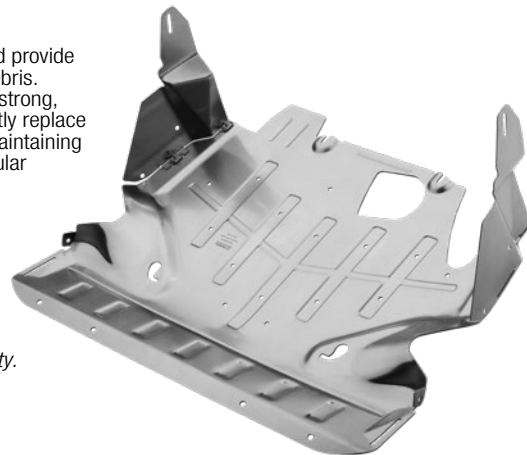

Side Window Deflectors

Keep inclement weather out and allow fresh air in.

- ✦ Engineered with the vehicle for a seamless fit and complementary appearance vs. aftermarket parts.
- ✦ Evaluated for water intrusion.
- ✦ Tested to help reduce wind noise and vibration.

F0010SL000

May not be legal in all states. Please check the laws of your state.

Severe Weather Companion

The Severe Weather Companion contains just about everything needed to handle an unexpected weather emergency while traveling. Included are items which help provide the basic necessities such as warmth, light, water, first aid, and the ability to signal for help; all packaged in a handy padded canvas carrying case.

SOA868V9502



Roadside Emergency Kit

The Genuine Subaru Roadside Emergency Kit contains a range of essential items to assist you in an automotive emergency. Including jumper cables, a reflective triangle, a first aid kit and more. The kit is designed to help keep you safe and dry – and get you on the road again. The components of the kit are packaged in a padded, embroidered carrying case.

SOA868V9511



First Aid Kit

Contains practical supplies to treat minor scrapes and scratches. The kit includes an assortment of self-adhesive bandages and gauze, adhesive tape, scissors, tweezers, an emergency blanket, a first aid guide and more. Contents are packaged in a zippered, Subaru-branded bag for easy accessibility.

SOA9031300



Express yourself.

With a refined exterior design, striking headlight styling and a bold new grille, your Subaru Forester will grab attention on every road traveled. Let your unique personality shine with the addition of Genuine Subaru Accessories.





Exterior Graphics – Side

Add a stylish touch to your Forester to express your love for adventure. Exterior graphics feature a mountain range that is ideal for the outdoor enthusiast.

- ✦ *Designed and tested to meet stringent Subaru durability requirements.*
- ✦ *PVC film construction with contrasting black and gray tones.*
- ✦ *Die-cut and sized to precisely fit just above the lower door cladding.*

J121SSL000

Key Chain – Stainless Steel

Made from 1/8-inch thick 304-stainless steel, with a brushed finish and permanent black laser-etched graphics.

SOA342L162

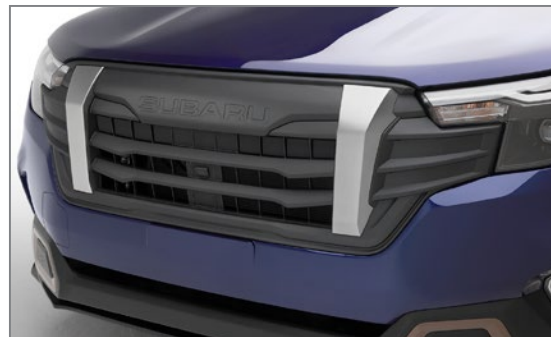

Accessory Grille

Express your adventurous side by adding a rugged look to the front of your Forester.

J1010SL000

Key Chain – Carbon Fiber

Carbon fiber composite and stainless steel key chain with leather strap and universal split ring.

SOA342L155





LED Upgrade

Enhance the illumination of your standard interior visor lights with brighter, whiter and crisper LED lighting.

- ✦ *Developed to rigorous Subaru standards for seamless operation and uninterrupted functionality.*
- ✦ *Tested to help ensure the safety of your vehicle's electrical infrastructure.*
- ✦ *Evaluated and carefully color-tuned for flattering lighting.*

H461SSJ010

Not applicable to Base trim.



Door Projector Lights

Adds to the vehicle's styling by projecting a silhouette of the Forester vehicle onto the ground when the door is opened.

H4610SL100



Footwell Illumination Kit

Illuminate dark corners of the front floor area and upgrade the interior ambiance with a soft white glow.

- ✦ *LED lights install securely into designated, prearranged locations.*
- ✦ *Brightens and dims in conjunction with vehicle interior lighting.*
- ✦ *Integrated into vehicle's electrical infrastructure for uninterrupted functionality.*
- ✦ *Optional blue and red replacement bulbs sold separately. Requires wire harness.*

H461SSL010

H461SSL011 (Wire Harness)

H461SSL013 (Blue Bulbs - set of 2)

H461SSL014 (Red Bulbs - set of 2)

Genuine Subaru License Plate Frames are manufactured from superior quality 304-stainless steel that will not rust or corrode and feature a 2-hole design. Kits include matching hardware fastener caps for a seamless appearance.



License Plate Frames – Slim Line

Feature a 1/2" frame width around all four sides.

SOA342L104 (Stainless Steel)
SOA342L105 (Matte Black)



License Plate Frames – Slim Line (Subaru)

Frames display the Subaru logo and feature a 1/2" frame width around all four sides.

SOA342L152 (Stainless Steel)
SOA342L153 (Matte Black)

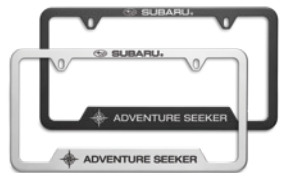

License Plate Frames – Adventure Seeker

You pick the adventure, your Subaru will get you there. Adventure Seeker license plate frames are for the explorer. Feature a 1/2" frame width around the top and sides and 1-1/8" width bottom.

SOA342L163 (Matte Black)
SOA342L164 (Stainless Steel)



License Plate Frames (Subaru)

Frames display the Subaru logo in UV-resistant polyurethane coating and feature a 1/2" frame width around the top and sides and 1-1/8" width bottom.

SOA342L127 (Stainless Steel)
SOA342L167 (Matte Black)



License Plate Mounting Bracket – Universal Fit

With four holes across the top, the license plate mounting bracket can be installed without drilling on models with existing bumper holes. Stainless steel with black powder coated finish. Includes mounting hardware for easy installation.

SOA342L171



License Plate Frame (Slim Line) and License Plate Mounting Bracket – Universal Fit

This set includes a slim line license plate frame and front license plate frame mounting bracket.

SOA342L169 (Stainless Steel)
SOA342L170 (Matte Black)

Valve Stem Caps

Add a finishing touch to your Subaru. These caps feature the Subaru star cluster and an "O" ring seal to help keep the valve orifices clean.

SOA342L137 (Chrome)
SOA342L168 (Black)



Subaru Oil Cap

Replacement oil cap is machined from billet aluminum, anodized in blue and laser-etched with the Subaru logo.

SOA3881330



Side Sill Plates – Front

Add some protection and dress up the front door sills. Side Sill Plates for Forester Sport trims feature a unique bronze finish to complement the styling of the vehicle. Silver-painted panels are applicable to all other Forester trims.

E101SSL000 (Base, Premium, Limited and Touring trims)
E101SSL020 (Sport trims)

Not recommended for use with Side Sill Plates – Illuminated.



Side Sill Plates – Illuminated

Illuminated side sill plates feature a unique outdoor landscape and the Forester logo in bright white lighting to add an attractive accent to the doorframe. Lighting is activated when the door is opened and turns off when the door is closed. Engineered to stand up to everyday wear and tear to keep your doorframe safe from scratches and scuffs.

H461SSL000

Not recommended for use with Side Sill Plates – Front.
 Delayed availability.



Rear Gate Inset Lettering

Precision-cut to seamlessly fit the debossed Forester name on the rear gate to add a 3D letter effect and bold appearance.

- ✦ *Designed and tested to meet stringent Subaru durability requirements.*
- ✦ *Peel-and-stick application for easy installation.*
- ✦ *Available in silver or black.*

J1210SL100 (Silver)

J1210SL110 (Black)

STYLE

Add a splash of color to the standard geometric trim accents on the lower door trim, front, and rear bumpers.

- ✦ *Constructed of high-quality material for long-lasting durability.*
- ✦ *Designed specifically for the Subaru Forester for a precise fit and finish.*
- ✦ *Replace bronze factory-installed accents on Sport trims and black factory-installed accents on all other Forester trims.*
- ✦ *Available in blue or silver.*

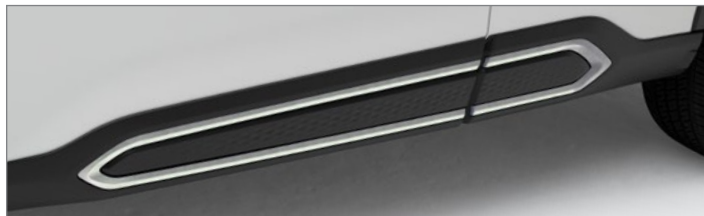
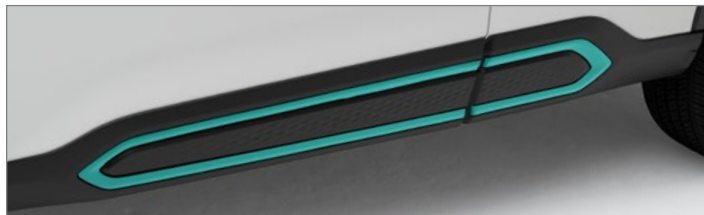

Lower Door Trim

E5510SL100 (Blue)
E5510SL120 (Silver)



Front Bumper Trim

E5510SL000 (Blue)
E5510SL020 (Silver)



Rear Bumper Trim

E5510SL200 (Blue)
E5510SL220 (Silver)

Transform your travels into pure perfection.

Surround yourself in a premium interior with safety attributes from Subaru you've come to trust and love. Keep your belongings in place and your passengers confident and relaxed with Genuine Subaru Accessories and elevate all your journeys into the most enjoyable experience.



Cargo Net

Neatly holds cargo and prevents it from sliding while the vehicle is in motion. The Cargo Net can be used two ways: anchor it to the sides of the cargo area to help prevent shifting from front to back or lay it across the floor to help keep things from rolling around.



F551SSL000



Phone Holder – Cup Holder Mounted

Designed to securely hold your mobile phone in either portrait or landscape position, and can be tilted at a variety of angles. The phone holder includes a tray to hold small personal belongings and is easily installed by inserting into the center console cup holder.

SOA800P000





Cargo Separator

Serves as a partition between 2nd row seating and cargo area to help provide additional passenger safety when transporting cargo in the rear of the vehicle.

- ◆ *Mesh design does not obstruct rear visibility.*
- ◆ *Designed with open areas on both sides for proper airbag deployment.*

F551SSL100

Not for use with child seats requiring tether straps or with pets. Cannot be used in conjunction with Cargo Sidewall Protector or installed Cargo Cover. Cargo Cover can be stowed under cargo floor and may be used separately.



Cargo Cover

Keep items in the back out of sight with this fully retractable, maximum coverage compartment cover.

65550SL000

Applicable to Base trim only. Cannot be used in conjunction with Cargo Separator. Can be stored in rear compartment when not in use.



Cargo Tray

Helps protect the cargo area from sand, water, stains, dirt and other messes while providing a surface that helps reduce the shifting of cargo while driving.

J501SSL200



Cargo Organizer

Conveniently transport your outdoor gear or up to four grocery bags neatly in the back. Quickly collapses for easy storage when not in use.

SOA567T100



Center Console Tray

Extra storage for convenience and organization. Color coordinated tray fits into the top of the center console.

J2010SL100



Moonroof Air Deflector

Helps reduce wind noise and sun glare.

F5410SL000

Cannot be used in conjunction with the Thule® Cargo Carrier – Extended.

Sunshade – Windshield

The foldable Sunshade offers a triple layer of protection to help reduce vehicle temperature up to 40 degrees. The Sunshade is custom-cut to fit properly, and includes a handy storage bag.



SOA9031100



Genuine Subaru Accessories are designed using original factory vehicle CAD data for a precise fit compared to "one size fits all" aftermarket additions.



Auto-Dimming Mirror with Compass and HomeLink®

Detects glare and darkens automatically to protect vision.

- ★ Features an 8-point digital compass.
- ★ Three backlit HomeLink® buttons can be programmed to operate most garage doors, security gates, home lighting, and more.
- ★ Provides status of garage door if programmed to a compatible opener with two-way communication.

H501SAN000

Not applicable to Touring trim.



Sunshade – 2nd Row

Keep your rear passengers comfortable with the 2nd Row Sunshade. When in use, these sunshades dull sun glare and reduce temperatures, as well as provide UV-A/B protection. Custom designed to function with all safety features.

F501SSL000

Not for use when the windows are fully open while the vehicle is in motion.

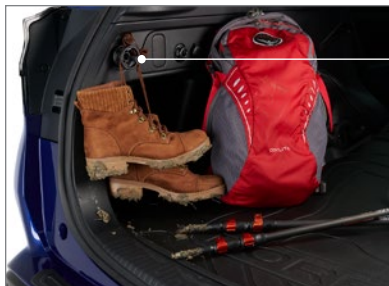

Utility Hook (2-pack)

Positioned on the left and right sides of the cargo area to hang personal items and gear. This utility hook can also be used to mount a utility bar (included with Cargo Shelf accessory), or to anchor the Cargo Net when in the upright position. Comes in a set of two.

- ◆ 6.6 lb. weight capacity per hook.
- ◆ Designed to accommodate use of a carabiner in any position.
- ◆ Ideal to hang backpacks, hiking shoes or other gear.

F5510SL010



Utility Hook Kit (2-Pack)

Available for Forester models with manual or power rear gate, the hook can be used to hang personal items or gear when the rear gate is opened. Comes in a set of two.

- ◆ 2.2 lbs. weight capacity per hook; 4.4 lbs. total weight capacity.
- ◆ Designed to accommodate use of a carabiner in any position.

F5510SL050 (Power Rear Gate)

F5510SL060 (Manual Rear Gate)



Cargo Shelf

Divides the cargo area into two sections for organized, maximized storage of your gear. Allows you to transport lighter weight items on the top shelf, and baggage or other heavier items below on the cargo area floor. Easily folds flat for storage when not in use.

- ◆ Includes two utility bars and four cargo area utility hooks, required for use.
- ◆ 11 lbs. total weight capacity.
- ◆ Can also be used with Cargo Net in the upright position.

F5510SL110



Ash Tray

Fits conveniently in the center console cup holder. Easily removed to empty contents.

92172AG040

Requires Ash Tray Holder.



Ash Tray Holder

Helps to give the ash tray accessory a snug fit in the center console cup holder.

F6010AG010

Remote Engine Starter

Allows vehicle to be started with the push of a button. The start/stop button blinks to confirm the engine has been started. Push Start works in conjunction with the Keyless Access and Start system and is an alternative to STARLINK® Safety Plus and Security Plus Package enrollment.

- ◆ Adjusts vehicle interior temperature for comfort upon entry.
- ◆ Starts vehicle up to 400 feet away depending on obstructions.

H001SSL000 (Push Start)

H001SSL100 (Key Start)

Delayed availability.



Take it to the limit.

Whether exploring the great outdoors miles from home or taking a weekend break from the everyday routine, boldly go wherever you choose in your Subaru Forester. With Genuine Subaru Accessories, you can pack more gear and excitement into any excursion.



Thule® Awning – Roof Mounted

Seamlessly integrates with your Subaru to provide shelter from the sun and rain. The awning features high strength fabric with an exclusive system for perfect canopy tension, and integrated telescopic support legs to help quickly setup and adjust to the correct height. When it's time to drive, easily stow and protect in a sleek, durable and lightweight aluminum case.

- ✦ *Integrated legs and tension arms allow for simple, one person setup.*
- ✦ *6.2 ft. in length and projects 8 ft. when fully extended.*
- ✦ *Suitable for use on vehicles with a crossbar set.*
- ✦ *Includes locking adapter kit for mounting to the crossbars and stakes to secure the legs to the ground.*
- ✦ *When used on a hard surface, weights are recommended to anchor and stabilize the legs.*
- ✦ *Can be used in conjunction with the Thule® Roof Top Tent or other Genuine Subaru Lifestyle roof top accessories.*

SOA567C200

Thule® Roof Top Tent

A modern shape and spacious interior transform your vehicle into a home away from home, providing more living space for you and for your gear. Features panoramic skylights and windows to help keep you cool and the tent well ventilated, and a dual-layer foam mattress for increased comfort.

- ◆ *2-3 person capacity: sleeps two adults and one child, or two adults comfortably.*
- ◆ *Lockable mounting brackets secure the tent to the Thule® Crossbar Set – Aero Extended.*
- ◆ *Removable rain cover with three modes of protection – heavy rain, rain protection with visibility through windows and skylights, and ready-to-deploy mode.*
- ◆ *Six dual-zippered panels for the door, window, and four skylights feature a bug screen and water-resistant polyester panel for privacy.*
- ◆ *Zippered travel cover protects the tent from the elements when the tent is stowed on top of the vehicle.*
- ◆ *Telescoping aluminum ladder allows easy access to the roof top tent and functions as a critical support to stabilize the weight of the tent and its occupants; top ladder rungs must be compressed at the top for stability.*
- ◆ *Suitable for use on Subaru vehicles equipped with factory raised roof rails and adequate roof capacity. Consult vehicle owner's manual for total roof load limit.*
- ◆ *Quick and easy deployment in three minutes or less: unzip the travel cover, unfold the base and secure the ladder properly to begin your camping adventure!*

SOA567C100

Requires Thule® Crossbar Set – Aero Extended.

- ◆ *Open dimensions: 95" x 56" x 44"*
- ◆ *Closed dimensions: 49" x 56" x 11"*
- ◆ *Sleeping footprint: 95" x 51"*
- ◆ *Peak internal height: 40.2"*
- ◆ *Weight of tent: 128 lbs.*



Crossbar Sets

Use in conjunction with Genuine Subaru roof attachments and carriers to increase your vehicle's cargo-carrying capabilities. Designed for quick and easy installation and removal. Consult vehicle owner's manual for total roof load limit.



Crossbar Set – Aero

- ★ *Designed and validated to minimize wind noise.*
- ★ *Use with low-profile style roof rail.*
- ★ *Does not support the use of roof top tents.*

SOA843X048 (Sport and Touring trims)

Delayed availability.



Crossbar Set – Aero

- ★ *Designed and validated to minimize wind noise.*
- ★ *Use with ladder-style roof rail.*
- ★ *Does not support the use of roof top tents.*

SOA843X045 (Base, Premium and Limited trims)



Thule® Crossbar Set – Aero Extended

- ★ *Features large surface area to mount multiple accessories.*
- ★ *Aerodynamic profile helps minimize wind noise.*
- ★ *Suitable for use with roof top tents.*

SOA567X010 (Base, Premium and Limited trims)

SOA567X091 (Sport and Touring trims)



Trailer Hitch Cap

Designed to fit 2-inch trailer hitches, this cap is made from rubberized exterior grade plastic with a screen printed Subaru logo in UV-resistant polyurethane.

SOA342L172



Trailer Hitch

Subaru hitches are engineered and crash tested to the same rigorous safety standards as the rest of the Forester. Heavy-duty 2-inch receiver rated at 1,500 lbs. maximum towing capacity, 150 lbs. tongue weight. Requires hitch and harness for proper operation and safety compliance.

L101SSL000 (Trailer Hitch)

L101SSL200 (Ball Mount)

H771SSL100 (Trailer Hitch Harness)

Ball mount sold separately. Hitch ball not included. Trailer brakes may be needed. Trailer hitch requires removal of rear gate foot sensor on applicable trims.

Thule® Cargo Carriers

Provide additional cargo-carrying capacity and feature dual-side opening for easier loading and unloading from either side of the vehicle. The low-profile, aerodynamic design provides increased garage access without sacrificing box capacity and the Quick-Grip™ mounting system allows for an easy, tool-free installation and removal.*



Thule® Cargo Carrier

- ◆ 13 cubic feet lockable storage capacity.
- ◆ Measures 65" L x 34.5" W x 16" H.

SOA567C023

Thule® Cargo Carrier – Extended

- ◆ 17 cubic feet lockable storage capacity.
- ◆ Measures 84" L x 34.5" W x 17" H.

SOA567C032

Cannot be used in conjunction with the Moonroof Air Deflector.

Thule® Paddleboard Carrier

Telescoping design provides a custom fit to transport boards up to 34" wide. Holds up to two boards.*

- ✦ Heavy-duty, steel-reinforced webbing.
- ✦ Improved locking mechanism for security.
- ✦ Soft, weather-resistant padding protects boards during transit.

SOA567P011



Thule® Ski and Snowboard Carrier

Securely holds up to six pairs of skis or four snowboards.*

- ✦ Ultra-soft rubber arms grip without scratching surfaces.
- ✦ Features 30" wide loading platform.
- ✦ Includes four locks to lock gear to the carrier and carrier to vehicle.

SOA567S011



Thule® Heavy-Duty Roof Cargo Basket

Provides additional storage space with easy access to load and unload gear of all shapes and sizes.*

- ✦ Low-profile design and tapered sidewalls.
- ✦ Custom fairing to help deflect wind.
- ✦ Includes black stretch net with hooks.
- ✦ Measures 50.25" L x 41" W x 6" H.

SOA567C011



Thule® Kayak Carrier

J-style design cradles and supports one kayak up to 36" wide and up to 75 lbs. during transport.*

- ✦ Steel design and adjustable padding for protection.
- ✦ Wide-mouth profile for easy loading and unloading.
- ✦ Folds down when not in use for increased overhead clearance and improved fuel economy.
- ✦ Includes straps and tie downs.

SOA567K010



Thule® Bike Carriers – Hitch Mounted

Designed to properly attach to the Genuine Subaru Trailer Hitch to securely transport bicycles. The anti-sway cages prevent bike-to-bike and bike-to-vehicle contact. Arms fold down when not in use and the rack pivots backwards for rear of vehicle access. Integrated locking cable and locking hitch pin lock the bikes to the carrier and carrier to the vehicle. Easy to handle, install and remove. See instructions for details.

Requires Trailer Hitch.

To avoid blocking taillights, use roof mounted bike carriers to transport bikes with solid disc wheels. Before installing this carrier, please check the laws of your state regarding license plate visibility.

Thule® Bike Carrier – Hitch Mounted (2-bikes)

- ◆ *Lightweight, aluminum rack is nearly half the weight of most hitch racks.*
- ◆ *Requires Thule® 2-inch hitch adapter.*
- ◆ *Two bike, 70 lbs. total weight capacity.*



SOA567B042

SOA567H011 (2" Adapter)



Thule® Bike Carrier – Hitch Mounted (4-bikes)

- ◆ *Durable steel construction.*
- ◆ *Designed to attach to the 2-inch Genuine Subaru Trailer Hitch.*
- ◆ *Four bike, 150 lbs. total weight capacity.*



SOA567B051



Thule® Bike Carrier – Hitch Platform (2-bikes)

Designed to transport mountain or downhill bikes, ebikes, fat bikes or bicycles with carbon frames. Rack tilts down for rear of vehicle access and folds up when not in use. Includes locks to secure bikes to the carrier and the carrier to the vehicle. See instructions for details.

- ◆ *Durable steel construction.*
- ◆ *Designed to fit 1-1/4-inch receiver.*
- ◆ *Fits most 20" to 29" wheels with tires up to 5" wide.*
- ◆ *Requires Thule® 2-inch hitch adapter.*
- ◆ *Two bike, 100 lbs. total weight capacity.*

SOA567B060

SOA567H011 (2" Adapter)

Requires Trailer Hitch.

To avoid blocking taillights, use roof mounted bike carriers to transport bikes with solid disc wheels. Before installing this carrier, please check the laws of your state regarding license plate visibility.



Thule® Bike Carrier – Fork Mounted

Features a sliding rear wheel cradle to securely transport one bicycle. Includes one lock to securely lock the bike to the carrier and the carrier to the vehicle.*

- ✦ Fits most bikes with up to 2.6" wide tires.
- ✦ Corrosion-resistant, low-profile, lightweight aluminum tray.
- ✦ Ratcheting wheel strap secures the rear wheel.
- ✦ Integrated mounting clamps to easily install and switch between compatible vehicles.

SOA567B011

Requires Thule® Crossbar Set – Aero Extended when installed on Sport and Touring trims.



 Subaru engineers work hand-in-hand with Thule® during the design and development of Genuine Subaru Lifestyle Accessories. A comprehensive series of tests are performed to ensure all racks and carriers comply with stringent Subaru requirements.

Thule® Bike Carrier – Roof Mounted

Features self-adjusting jaws that automatically wrap around the downtube for precise frame hold. Includes one lock to securely lock the bike to the carrier.*

- ✦ Fits most 20" to 29" wheel bikes with up to 2.6" wide tires.
- ✦ Adjustable mounting clamps to easily install or switch between compatible vehicles.

SOA567B020



Thule® Portable Step

Get the extra height you need to easily access all of your roof top Lifestyle Accessories with the convenience of the Thule® Portable Step. Constructed of heavy-duty steel; rubber bumpers are included to help prevent wheel scrapes and scuffs. This step conveniently folds into a carrying bag for easy storage.

SOA567W010

Capable and connected.

Your Subaru Forester is already designed to make it easier to view and control your navigation, music, podcasts and other content. With Genuine Subaru Accessories, you'll keep your devices charged for seamless connectivity on every commute.



USB Charging Cable Set

Quickly charge mobile devices while you're on the go. Designed in signature Subaru blue, Genuine Subaru cables offer superior quality and durability compared to typical aftermarket cables. Packaged in a zippered Subaru-branded storage case, the set of four, 3 ft. cables allow you and your passengers to charge and connect while on the road.

- ✦ Includes Velcro® cable ties to keep cables neat, tidy and organized when not in use.
- ✦ Universal compatibility designed to work flawlessly with any device that uses a USB-A or USB-C port.
- ✦ Includes MFi-certified, unique and verified serial number and authorization chip issued by Apple® to ensure compatibility with any Lightning® device.
- ✦ Supports multiple charging specifications; USB-A to Lightning, USB-C to Lightning, USB-A to USB-C, USB-C to USB-Power Delivery, Qualcomm® Quick Charge™, Samsung® adaptive charging, Android Auto™ and Apple CarPlay® using the USB media port.

H671SFN000



Wireless Charger

Conveniently charge your phone without the hassle of tangled wires. The Wireless Charger is a Qi-Certified Device with intelligent charging profiles, cell phone battery protection, temperature control technology and short circuit safeguards. Compatible with all Qi-enabled devices.

H1010SL010

Applicable to Base trim only.

Protect and pamper your pets.

Help keep your furry family safe and secure on any road you travel together. With Genuine Subaru Pet-friendly Accessories, your pet will feel right at home.





Collapsible Pet Kennel

Portable, compact, lightweight and constructed of durable, black polyester fabric and a steel tube frame. Designed with three large integrated zippered openings for easy pet access. Includes carrying handle to easily transport when not in use and two pockets to carry your pet's personal cargo. Manufactured by Thule®.

- ◆ *Designed for travel and everyday transport of your pets.*
- ◆ *Easy-to-use alternative to cumbersome metal carriers.*
- ◆ *Secures in the cargo area with four adjustable straps and carabiner hooks.*

SOA567P100 (Medium)
SOA567P200 (Large)

The Collapsible Pet Kennel, manufactured by Thule®, is backed by a 2-year warranty through Thule®. Please visit <https://www.thule.com/en-us/about-thule/warranty> for details.



License Plate Frames – Pet Lover

At Subaru, pets are part of the family. Share your love for your furry, scaly or feathered friends with our Pet Lover license plate frame. Subaru Pet Lover frames are manufactured from heavy-gauge 304-stainless steel that will not rust or corrode, and feature a 1/2" frame width around the top and sides and 1-1/8" width bottom.

SOA342L165 (Matte Black)
SOA342L166 (Stainless Steel)



Rear Bumper Protector Mat

Helps protect top surface of rear bumper when your pets are entering and exiting the vehicle.

E101EAJ501

When not in use, folds flat on cargo floor or under cargo tray.



Pet-friendly Padded Cargo Liner

Provides a comfortable resting area for your pet while protecting the cargo area and seatbacks from pet hair, nail scratches, accidents and spills.

- ★ Features thick padding and durable polyester shell.
- ★ Includes foldout bumper protector for added protection.
- ★ Integrated zipper allows for 60/40 seats to be up or down when in use.
- ★ Easy installation: latches attach to the lower cargo mounting loops and rear child seat tether points.
- ★ Adjustable straps affix to headrests and Velcro® mounting straps attach at various locations for increased stability.
- ★ LATCH-accessible, machine-washable, easy to vacuum or wipe clean.

J501SSL280



Organizer and Pet Rear Seat Extender

Increase the back seat resting area for your dog to stretch out comfortably during long trips, while providing storage space for pet gear and other personal items.

- ★ Conforms to the shape of the rear seat to match seat height and minimize the gap between the seat and the extender.
- ★ Helps keep your pet calm and comfortable by filling the gap between front and rear seat.
- ★ Suitable for dogs up to 200 lbs.
- ★ Includes dividers to keep personal items well organized and provide a sturdy structure to support your pet's weight.
- ★ Easy to clean and quickly folds flat for storage when not in use.
- ★ Two required to cover the driver and passenger side back seat areas.

J201SSL000





Pet-friendly Padded Seat Protector

Protects the back seat from muddy paws and pet hair while your pet travels in padded comfort. Designed without buckles or straps, installation and removal is quick and easy with removal and reinstallation of the headrests and repositioning of the seatbelt through a Velcro® opening in the protector.

- ✦ Heavy-duty quilted seat pad and tailored seatback for maximum coverage.
- ✦ LATCH-accessible, machine-washable and water-resistant.
- ✦ Suitable for use with child car seats and rear passengers.

F411SSL020

60/40 seat functionality compromised when in use.



Console Lid Protector

Protects the center console lid surface from nail scratches and puncture holes, and provides a comfortable armrest for front seat passengers.

- ✦ Multi-layered padded interior for increased comfort.
- ✦ Secured with two durable integrated elastic straps.
- ✦ Non-slip bottom helps keep it in place.

J201SSL010



Seat Cover – Rear

Tailored to provide a snug fit to help keep your second row tidy. Install with integrated straps and buckles. Made with a polyester front and polyurethane coated back, the cover is great for pets, kids and life on the go.

- ✦ Includes full protection to the rear headrests.
- ✦ LATCH-accessible, machine-washable and water-resistant.

F411SSL010

60/40 seat functionality is preserved when in use. Not applicable to Base trim.



Pet Harness

Buckle up your dog for safety before you begin your road trip together. Infinity Loop webbing design, padded vest, seatbelt grade straps and stress-tested buckles work together to distribute and reduce damaging forces in the event of a car collision. Manufactured by Sleepypod® in signature Subaru blue. Refer to the sizing guide to determine the correct size for your dog.

- ✦ *Crash-tested at child safety seat standards and certified by the Center for Pet Safety for dogs 18-90 lbs.*
- ✦ *Double "D" ring connection design to affix a leash.*
- ✦ *Reflective strips and logo for improved visibility at night.*

SOA854H000 (Small: 16.5" - 22")
SOA854H010 (Medium: 22.5" - 28")
SOA854H020 (Large: 28.5" - 34")
SOA854H030 (X-Large: 34.5" - 40")

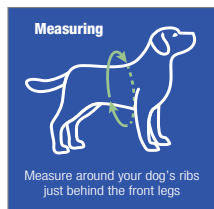

Pet Rear Door Protector

Helps protect your door panel from scratches, nail punctures, scuffs, dirt and dog drool. Comes in a set of two.

- ✦ *Lightweight, durable design to seamlessly fit the contours of the door.*
- ✦ *Heavy-duty polyester extends protection to the entire door panel.*
- ✦ *Features three clips for easy and secure installation onto the door panel.*
- ✦ *Easy to remove when cleaning is required.*

SOA773A003

Not recommended for use with aftermarket rear window tint.

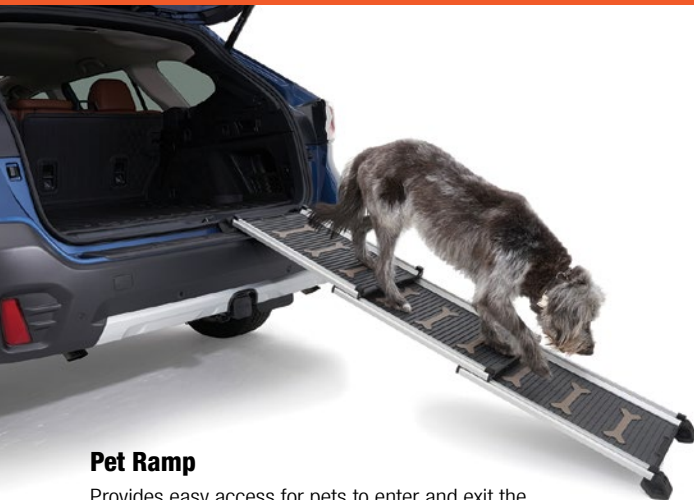

Pet Ramp

Provides easy access for pets to enter and exit the vehicle. Aluminum and plastic construction with rubberized feet to avoid shifting when in use.

- ✦ Especially suited for senior dogs and those with mobility issues.
- ✦ Non-slip ramp and high-grip ridged surface for safer footing in most weather conditions.
- ✦ Lightweight, telescoping design folds with ease to store when not in use.
- ✦ Supports pets up to 220 lbs.

SOA932P100

Use only for pets to enter and exit the cargo area. Not suitable for rear seat entry and exit.

Pet Carrier and Mobile Pet Bed

Multi-functional, ultra-plush pet bed provides comfort for your pet and helps make travel less stressful. Features zipper pulls to remove upper mesh dome, padded carry handle and adjustable shoulder strap. Manufactured by Sleepypod® and uniquely designed in Subaru blue.

- ✦ Doubles as a carrier and car seat to transport your small dog or cat in comfort and safety.
- ✦ Crash-tested and certified by the Center for Pet Safety.
- ✦ Designed with Velcro® positioning points to secure seatbelt straps when used as a car seat.
- ✦ Luggage-grade exterior easily wiped clean.
- ✦ Removable plush bedding is machine-washable.

SOA854S100

Suitable for pets weighing 15 pounds and under. Not suitable for use during air travel.



Pet Travel Bowl

Travel with your pet's food and water in one convenient, portable container. Freeze water in the base to keep water cool and wet food fresh. Manufactured by Sleepypod® and designed in distinctive Subaru blue.

- ✦ Lid doubles as a second bowl.
- ✦ Textured base helps resist spilling or tipping.
- ✦ Constructed of FDA food grade silicone, dishwasher and microwave safe and BPA free.

SOA854B001 (Small)

SOA854B002 (Medium)

Introduce performance to premium.



Designed with a bold exterior and innovative interior, the Subaru Forester takes sophistication in an SUV to a whole new level. Genuine Subaru STI Accessories let you add a touch of exhilaration to your travels, no matter where the road takes you.



STI Key Chain – Stainless Steel

Made from 1/8-inch thick 304-stainless steel, with a brushed finish and permanent black laser-etched STI logo.

SOA342L159



STI Key Chain – Carbon Fiber

Carbon fiber composite and stainless steel key chain with STI logo, leather strap and universal split ring.

SOA342L156



STI 18-inch Alloy Wheel Set

Helps give the Forester the perfect blend of attitude and style. The wheels are finished in black. Requires STI branded center cap: 28821FE141 (4 each) for a finished appearance.

B3110SJ071

Applicable to Limited trims only.





STI Valve Stem Caps

Add a finishing touch to your Subaru. These caps feature the STI logo and an "O" ring seal to help keep the valve orifices clean.

SOA342L136

STI Starter Switch

Upgrade the stock push start button with the STI Starter Switch. The cherry red button with STI logo in the center gives the interior of your Forester a sporty appearance.

H5010VC000

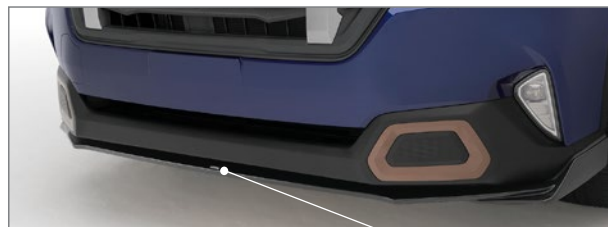

STI Under Spoiler – Front

The STI Front Under Spoiler gives the Forester a mean, ground-hugging look. Includes STI logo.

E2410SL000 (Black)

E2410SL010 (Red)



STI License Plate Frames

Frames display the STI logo in UV-resistant polyurethane coating and feature a 1/2" frame width around the top and sides and 1-1/8" width bottom. Made from heavy-gauge 304-stainless steel that will not rust or corrode.

SOA342L123 (Stainless Steel)

SOA342L126 (Matte Black)

STI Door Handle Cup Protector

Protects your door handle cup area. Comes in a carbon fiber pattern for a stylish accent.

J1210SJ500



STI Euro-Style Marque Plates

Manufactured from 304-stainless steel with the STI logo and available in matte black finish. Kit includes hardware hider caps.

SOA342L133



STI Flexible Strut Tower Brace

Innovative design improves driving dynamics without sacrificing the ride quality.

E4010FL001

STI Roof Spoiler

The flush mounted STI Roof Spoiler adds a sporty touch to the Forester. The spoiler is available in Crystal Black Silica and includes the STI logo.

E7210SL310





Subaru of America reserves the right to change or withdraw accessories at any time without prior notice and without incurring the obligation to make changes to any accessories previously sold. All images are representative.

Subaru, Forester, STARLINK and STI are registered trademarks. Android Auto is a trademark of Google LLC. Apple, CarPlay and Lightning are registered trademarks of Apple, Inc. HomeLink is a registered trademark of Gentex Corporation. The Center for Pet Safety (CPS) is a 501(c)(3) non-profit research and advocacy organization dedicated to consumer and companion animal safety. Qualcomm, Quick Charge and Qualcomm branded products are products of Qualcomm Technologies, Inc. and/or its subsidiaries. Samsung is a registered trademark of Samsung Electronics Co., Ltd. Sleepypod is a registered trademark. Velcro is a registered trademark of Velcro IP Holding LLC. Thule and Quick-Grip are registered trademarks of the Thule Group. *Roof accessories require Crossbar Set. Consult vehicle owner's manual for total roof load limit.

©2024 Subaru of America, Inc.

Printed in U.S.A.

MSA6A2405

